

Article number: 03508220

Description: Fluro Rod end GE 220FW-2RS

Measures

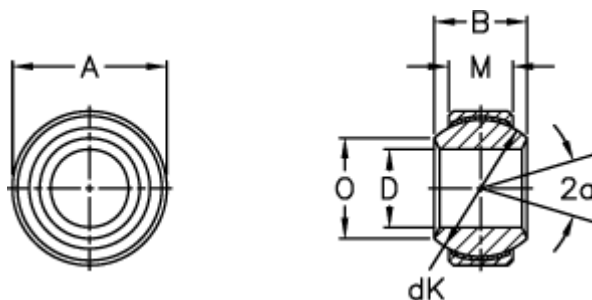

A = 340 0 -0,040

B = 175

D = 220 0 -0,030

dK = 300

Dynamic load C (kN) = 4800

M = 100

O = 243.6

Static load C0 (kN) = 9600

Tilt angle = 16

Weight = 50800